



Ratna Sagar

RATNA SAGAR

PRIMUS

BYWORD

E-LIVE

Education, Our Mission



ICSE

Living Science

Physics

Class 10

Chapter 4 Gravitation



As per the latest ICSE syllabus

9



Living Science

PHYSICS



Dhiren M Doshi

Rama Sagar

EDUCATION, OUR MISSION



LEARNING OBJECTIVES

Newton's Universal Law of Gravitation

- ❖ Universal gravitational constant
- ❖ Value of G
- ❖ Importance of Newton's universal law of gravitation

Free Fall

- ❖ Robert Boyle's experiment
- ❖ Relation between G and g
- ❖ Variation of acceleration due to gravity g
- ❖ Calculation of acceleration due to gravity g

Equations of Motion for Freely Falling Bodies

Mass and Weight

- ❖ Characteristics of weight
- ❖ Gravitational units of force

Gravitation, Gravity and Gravitational Force

The phenomenon of attraction between different bodies in the universe is called **gravitation**.

The force of gravitation exerted by the earth on any object is called **gravity**.

Any two particles (or objects) in the universe attract each other with a force called **the force of gravitation** or **gravitational force**.



Newton's Universal Law of Gravitation

Every body in the universe attracts every other body with a force which is directly proportional to the product of their masses and inversely proportional to the square of the distance between them. The force acts along the line joining the centres of the two bodies.

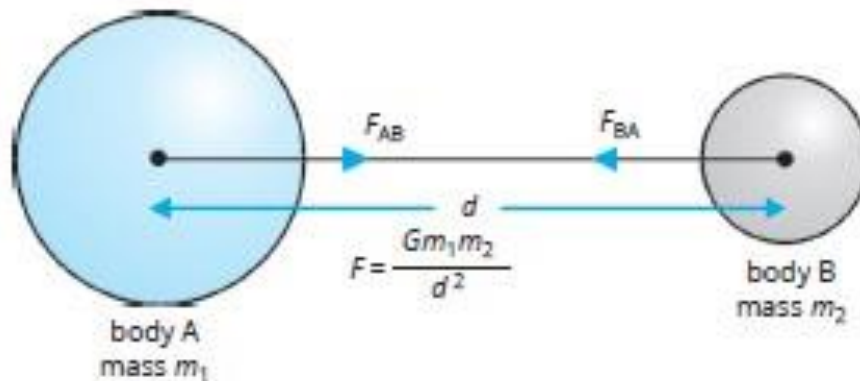

$$F = G (m_1 m_2) / d^2$$

where G is a constant of proportionality and is called the Universal Gravitational Constant.

Universal Gravitational Constant is equal to the force of attraction acting between two bodies each of unit mass (i.e. 1 kg) whose centres are placed unit distance (i.e. 1 m) apart.

- The SI unit of Universal Gravitational Constant (G) is $\text{N m}^2/\text{kg}^2$.
- The accepted value of G is $6.673 \times 10^{-11} \text{ N m}^2/\text{kg}^2$.



- Universal Gravitational Constant G is a **scalar quantity**.
- The value of G , $6.673 \times 10^{-11} \text{ N m}^2/\text{kg}^2$ is same throughout the universe.
- The value of G does not depend upon the nature, size or masses of the bodies.
- The value of G does not depend upon the nature of medium between the two bodies.

Importance of Newton's Universal Law of Gravitation

1. It is the gravitational force between the sun and all the eight planets which makes them move around the sun.
2. It is the gravitational force between the earth and the moon which makes the moon move around the earth.
3. It is the gravitational force exerted by the sun and the moon on the sea water leading to the formation of tides in the sea.
4. It is the gravitational pull of the earth which is responsible for holding the atmosphere near the surface of the earth.
5. It is the gravitational pull of the earth which is responsible for falling of rain and snow towards the surface of the earth.
6. The prediction about solar and lunar eclipses, made on the basis of Newton's Universal Law of Gravitation, always comes out to be accurate.



Free Fall

Whenever objects fall towards the earth only under the gravitational force of the earth (with no other forces acting on it), we say the objects are in the state of free fall. Galileo showed that all bodies, whether light or heavy, fall at the same speed towards the earth.

Robert Boyle's Experiment

Galileo's arguments were experimentally tested by the British scientist Robert Boyle. He kept a coin and a feather in a big glass jar. The air inside the jar was removed by using a vacuum pump. After evacuation of air from the glass jar, it was inverted. Both feather and the coin fell to the bottom of the jar at the same time, thereby proving Galileo right. Thus, acceleration produced in free falling bodies is the same and does not depend on masses of the falling bodies.

Acceleration due to gravity

The uniform acceleration produced in a body when it falls freely under the effect of gravity (gravitational force of earth) alone is known as acceleration due to gravity. It is denoted by the letter, g . The SI unit of g is the same as that of acceleration, i.e. m/s^2 .



Relation between g and G

According to Newton's Universal Law of Gravitation,

$$F = G Mm / R^2$$

But $F = ma = mg$

So, $mg = G Mm / R^2$

$$g = G M / R^2$$

The value of acceleration due to gravity g is independent of mass, shape and size of the body but depends upon mass and radius of the earth.

$$g = 9.8 \text{ m/s}^2$$

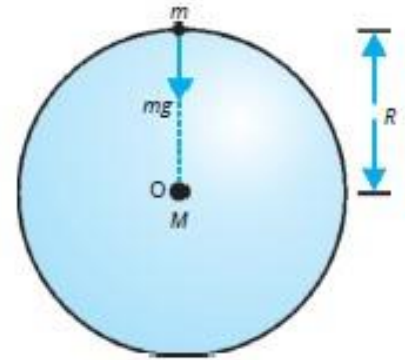

Variation of acceleration due to gravity (g)

$$g = (G \times M) / R^2$$

So, the value of acceleration due to gravity changes with height (or altitude), depth and shape of the earth.

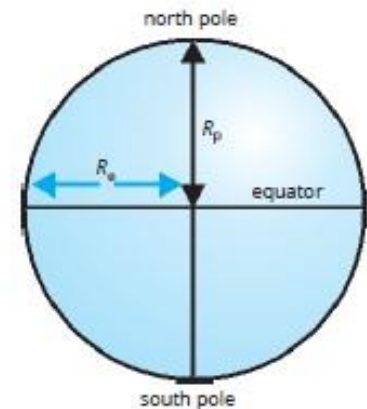

Effect of the shape of the earth

We know that $g \propto 1 / R^2$

As the radius of the earth is maximum at the equator, so the value of g is minimum at the equator, and since the radius of the earth is minimum at the poles, the value of g is maximum at the poles. It means the value of acceleration due to gravity, g increases as we go from equator to the poles.



Effects of altitude

We know that

$$g \propto 1/R^2$$

So, the value of g is inversely proportional to the square of distance from the centre of the earth.

Now, as we go above the surface of the earth, the distance from the centre of the earth increases and hence, the value of g decreases, i.e. **the value of g decreases with height (altitude)**. It is due to this reason that the value of acceleration due to gravity is lesser at mountains than on plains.

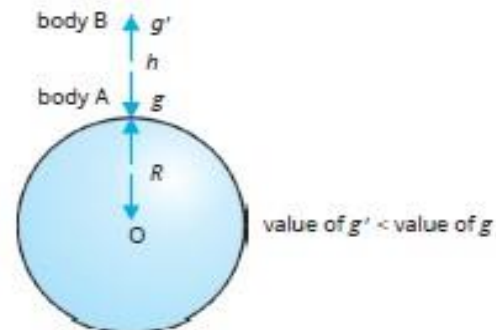

Effect of height

As we go below the surface of the earth, the acceleration due to gravity goes on decreasing and becomes zero at the centre of the earth.

So, the value of acceleration due to gravity is maximum at the earth's surface, decreases with depth and becomes zero at the centre of the earth.

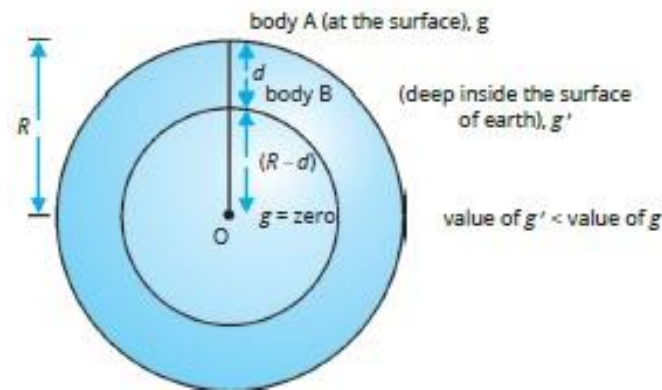

Note: Refer to Table 4.1 for Differences between G and g , and Table 4.2 for Differences between gravitation and gravity.



Equations of Motion for Freely Falling Bodies

General equations of motion

1. $v = u + at$

2. $S = ut + \frac{1}{2} at^2$

3. $v^2 = u^2 + 2aS$

Equations of motion for freely falling bodies

changes to $v = u + gt$

changes to $h = ut + \frac{1}{2} gt^2$

changes to $v^2 = u^2 + 2gh$

Points to remember

1. When a body is thrown vertically upwards **its final velocity, v becomes zero.**
2. When a body is dropped from a certain height, **its initial velocity, u is taken as zero.**
3. Acceleration due to gravity, **g is taken as negative when a body is thrown vertically upwards, i.e. g is taken as -9.8 m/s^2 .**
4. Acceleration due to gravity, **g is taken as positive when a body is dropped from a certain height, i.e. g is taken as $+9.8 \text{ m/s}^2$.**
5. Time taken by a body to reach the highest point is equal to the time it takes to fall from the same height.



Mass

Mass is the quantity of matter contained in a body. **The mass of an object is a measure of its inertia.** The more is the mass of a body, the harder it is to change its state of rest or of motion.

Characteristics of mass

1. Mass is a scalar quantity.
2. A body contains the same quantity of matter whether it is on the earth, the moon or anywhere in the universe, i.e. the mass of an object is the same everywhere. It does not change from place to place. It is constant.
3. The mass of a body can never be zero.
4. The SI unit of mass is kilogram (kg) and the CGS unit of mass is gram (g).

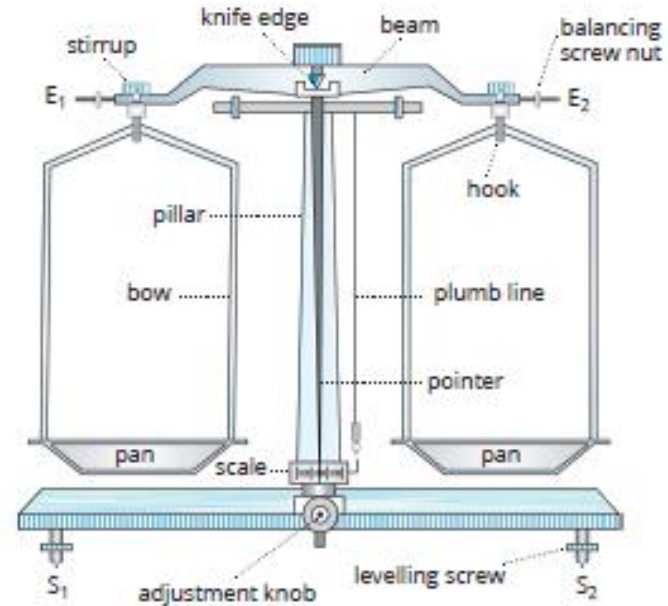

The mass of a body can be measured with the help of a two-pan balance (beam balance or physical balance).



Weight

The weight of a body is the force with which it is attracted towards the centre of the earth. It is represented by the symbol W .

$$W = m \times g$$

Weight of the body = Mass of the body \times Acceleration due to gravity

Characteristics of weight

1. It is a vector quantity having direction towards the centre of the earth, i.e. acting in vertically downward direction.

2. The weight of a body changes from place to place. The value of g is minimum at the equator and maximum at the poles. That is why, a body weighs more at the poles than at the equator. We know the value of g decreases with height (altitude). It is due to this reason that a body weighs lesser at the mountains than at the plains. We know the value of g is zero at the centre of the earth, so, the weight of the body at the centre of the earth will be zero.

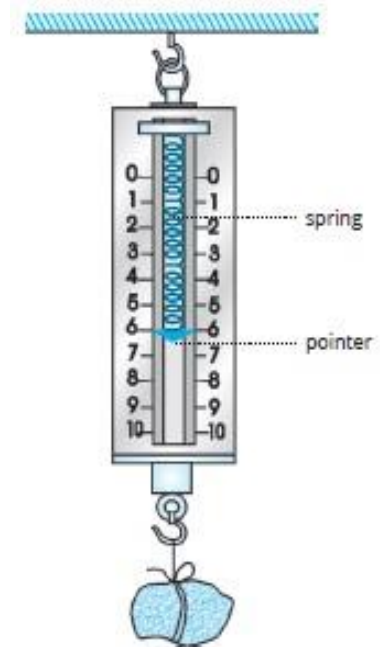

Weight is measured with a spring balance or by a weighing machine.



3. Since the value of g is constant at a given place, so at a given place, the weight of an object is directly proportional to its mass m . It is due to this reason that at a given place, **we can use the weight of an object as a measure of its mass.**

Gravitational Units of Force

1. Kilogram force: In MKS system, kilogram force (kgf) is the gravitational unit of force.

One kilogram force is defined as the force required to lift a body of mass 1 kg vertically upwards or the force due to gravity acting on a mass of one kilogram.

$$1 \text{ kgf} = 9.8 \text{ N}$$

2. Gram force: In CGS system, gram force (gf) is the gravitational unit of force. One gram force is defined as the force due to gravity on a mass of one gram.

$$1 \text{ gf} = 980 \text{ dyne}$$

Note: The differences between mass and weight are given in Table 4.3.



SUMMARY...

- 1. Gravitation:** Any two particles (or objects) in the universe attract each other by a force called gravitational force. The phenomenon of attraction between different bodies in the universe is called gravitation.
- 2. Newton's Law of Universal Gravitation:** Every body in the universe attracts every other body with a force which is directly proportional to the product of their masses and inversely proportional to the square of the distance between them. The force acts along the line joining the centres of the two bodies.
- 3. Acceleration due to gravity:** The uniform acceleration produced in a body when it falls freely under the effect of gravity alone is known as acceleration due to gravity.
- 4. Free fall:** Whenever objects fall towards the earth only under the gravitational force of earth, we say the objects are in the state of free fall.
- 5. Mass:** The quantity of matter contained in a body is called its mass.
- 6. Weight:** The weight of a body is the force with which it is attracted towards the centre of the earth.



RATNA SAGAR

PRIMUS

BYWORD

E-LIVE

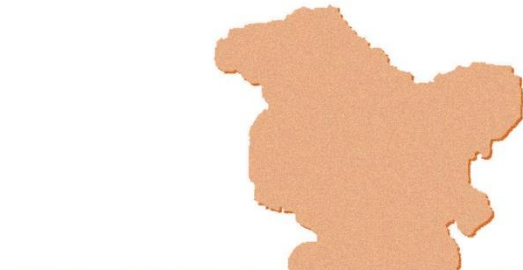

**THANK
YOU**